

AKZ/AG28 Series Canopy Replacement

Assembly and Operation Guide

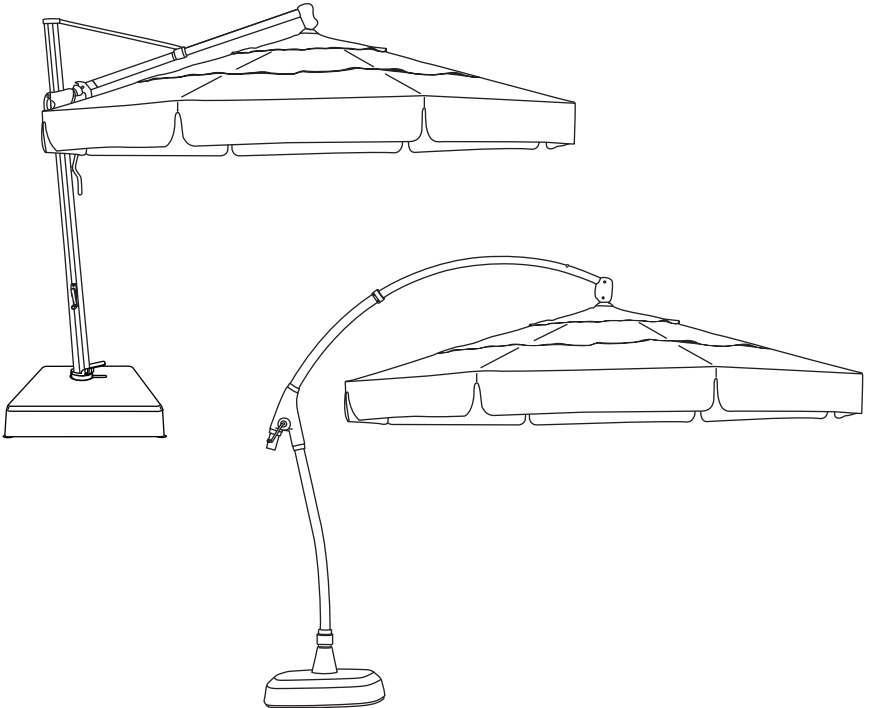

AKZ and AG28 CANOPY REPLACEMENT

STEP 1

Make sure umbrella is in closed position (Fig. 1).

For octagon canopies, please skip to Step 2.

For square and rectangle canopies, use a phillips screwdriver to unscrew all 8 screws from spring loaded rib end caps (Fig. 2) and set screws aside for later use.

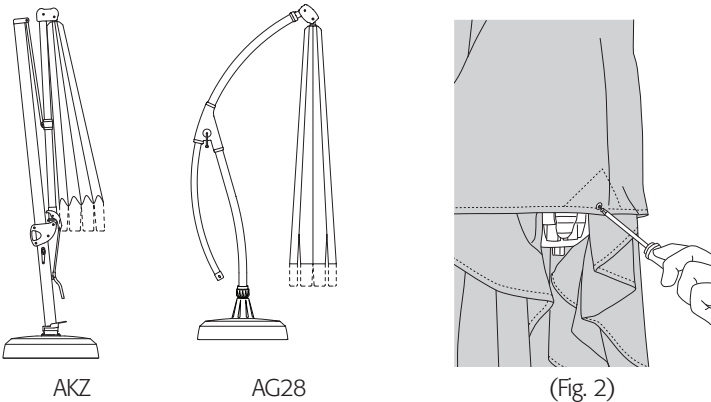

(Fig. 1)

STEP 2

NOTE: A ladder and two-person team recommended for canopy removal and replacement.

While one person holds the ladder for safety, the second person climbs the ladder until they reach top of the umbrella (Fig. 3).

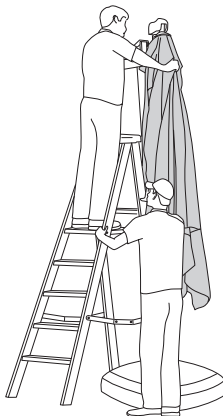

(Fig. 3)

STEP 3

From the top of the canopy, twist the back of the canopy towards you so you can access the velcro and zipper (Fig. 4). Open velcro flap and unzip canopy (Fig. 5). Begin to slide canopy down ribs (Fig. 6). Safely step down ladder and continue to remove canopy (Fig. 7).

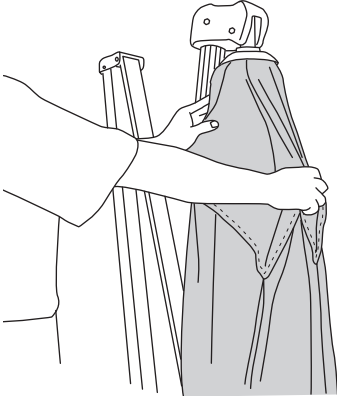

(Fig. 4)

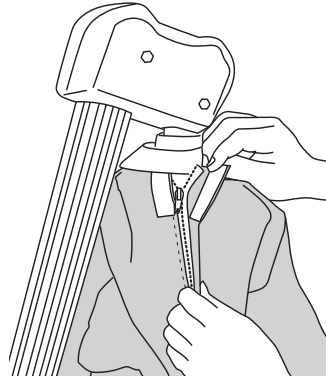

(Fig. 5)

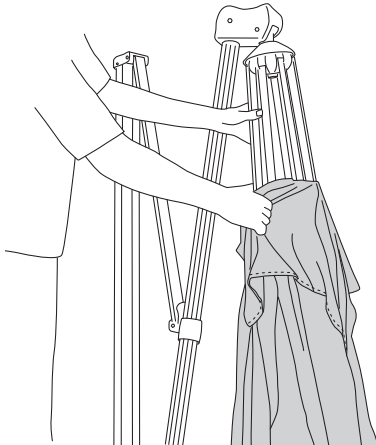

(Fig. 6)

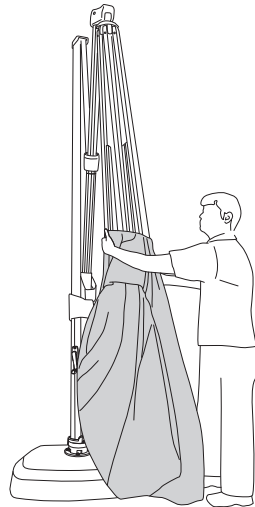

(Fig. 7)

STEP 4

Unfold new replacement canopy. Gather bottom of canopy (larger opening) to the top of canopy (smaller opening).

For octagon canopies, slide top opening of canopy over all 8 ribs (Fig. 8). For square and rectangle canopies, start by sliding top opening of canopy over the 4 longest ribs (Fig. 9). When the 4 longest ribs are inside canopy, pull the canopy up slightly and pull canopy over the 4 shortest ribs.

Once all 8 ribs are inside canopy, begin to slide canopy up while second person holds canopy to prevent canopy from dragging on floor and getting dirty (Fig. 10). Continue to slide canopy up ribs while safely climbing up ladder and second person moving over to ladder for extra support (Fig. 11).

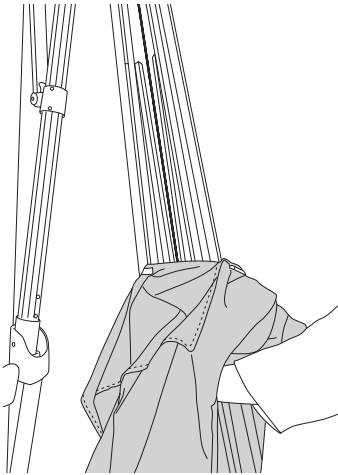

(Fig. 8)

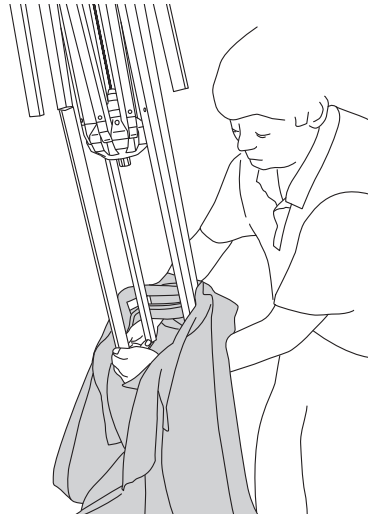

(Fig. 9)

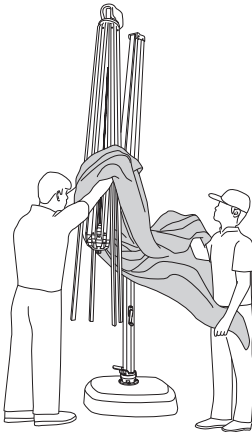

(Fig. 10)



(Fig. 11)

STEP 5

When you reach the top of the umbrella, slide canopy down under cap (Fig. 12).

NOTE: Make sure velcro and zipper on canopy are facing the back side (towards the canopy support arm). Velcro top together first to keep canopy from sliding back down ribs (Fig. 13). Zip up canopy and velcro flap together (Fig. 14). Tuck canopy under cap.

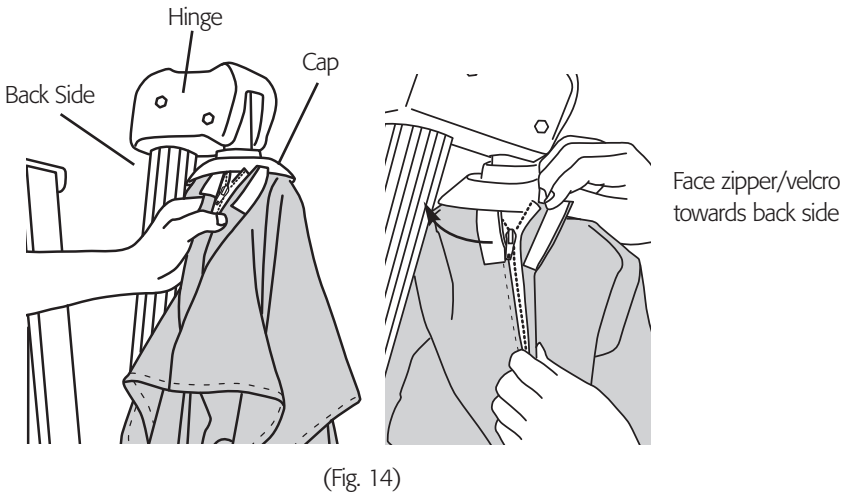
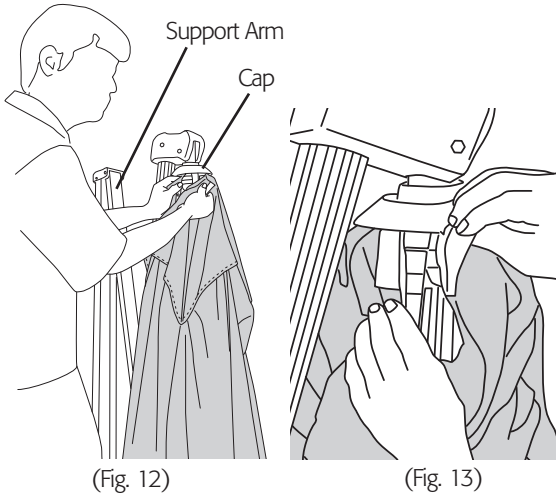

STEP 6

Safely climb down ladder. Line up ends of canopy with spring loaded rib ends.

For octagon canopies, slide spring loaded rib ends into canopy pockets located under canopy (Fig. 15).

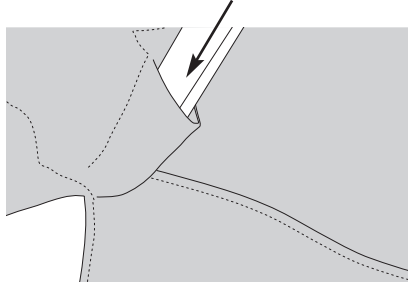

(Fig. 15)

For square and rectangle canopies, attach 8 screws back onto end of canopy and spring loaded rib end caps (Fig. 16).

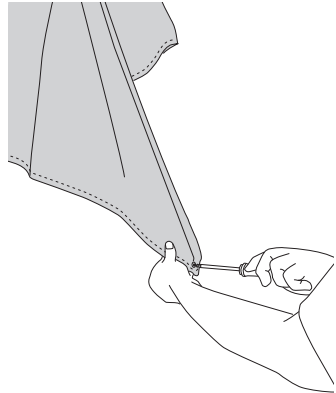

(Fig. 16)

Smooth out canopy as necessary. Your umbrella is now ready for use.



www.treasuregarden.com

©2017 Treasure Garden, Inc. - All Rights Reserved.

Rev. 2/17